

Data Sheet

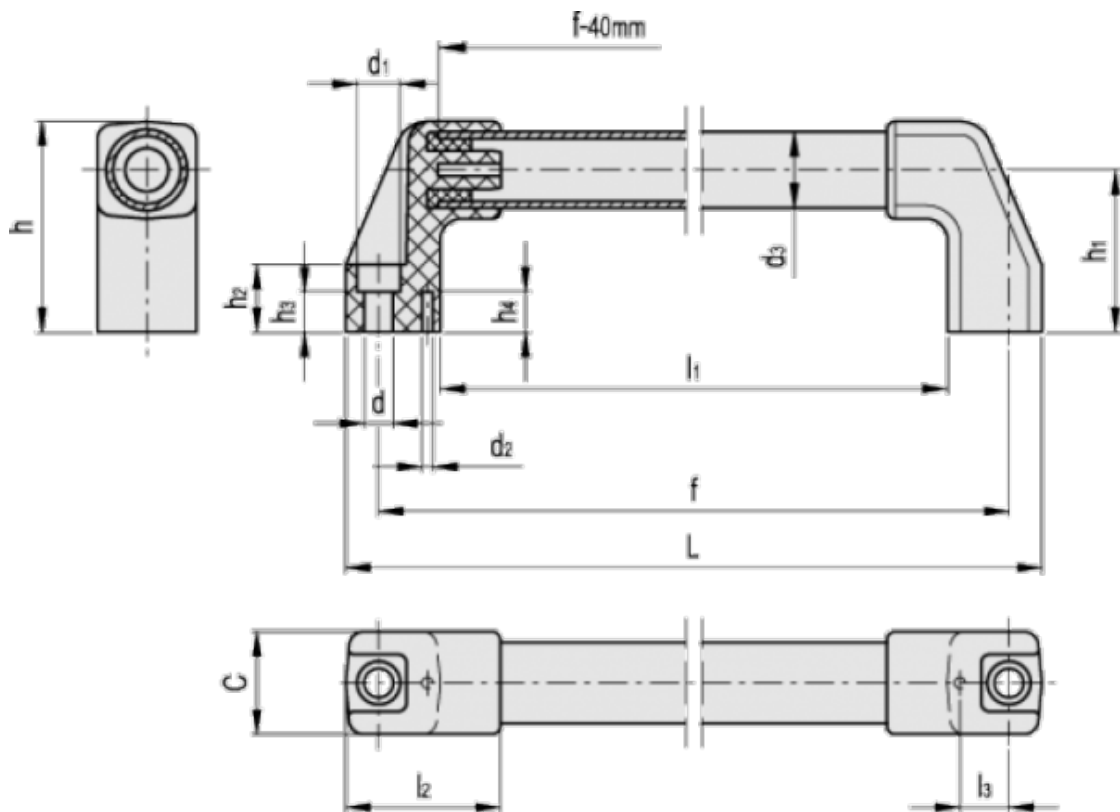

Article number: 2304037752
 Description: E+G Tubular handle
 M.1043/30-700-SST

Measures



c	= 38	h1 = 60	R = load at breakage in N = 3500
d	= 10.5	h2 = 25	
d1	= 16	h3 = 15	
d2	= 4	h4 = 15	
d3	= 30	L = 724	
E = Max . working load in N = 2250		l1 = 654	
f	= 700	l2 = 57	
h	= 78	l3 = 18	